

SPICE thermal model

BUK964R2-60E

Symbol	Parameter	Conditions	Min	Typ	Max	Unit
$R_{th(j-mb)}$	thermal resistance from junction to mounting base		-	-	0.57	K/W

C_{th1}	1.835E-04 F
C_{th2}	1.308E-03 F
C_{th3}	9.881E-04 F
C_{th4}	3.804E-03 F
C_{th5}	1.211E-02 F
C_{th6}	2.411E-02 F
C_{th7}	5.977E-01 F
C_{th8}	1.623E+02 F
R_{th1}	4.855E-04 Ω
R_{th2}	9.542E-04 Ω
R_{th3}	1.131E-02 Ω
R_{th4}	2.702E-02 Ω
R_{th5}	9.606E-02 Ω
R_{th6}	3.569E-01 Ω
R_{th7}	8.813E-02 Ω
R_{th8}	1.348E-03 Ω

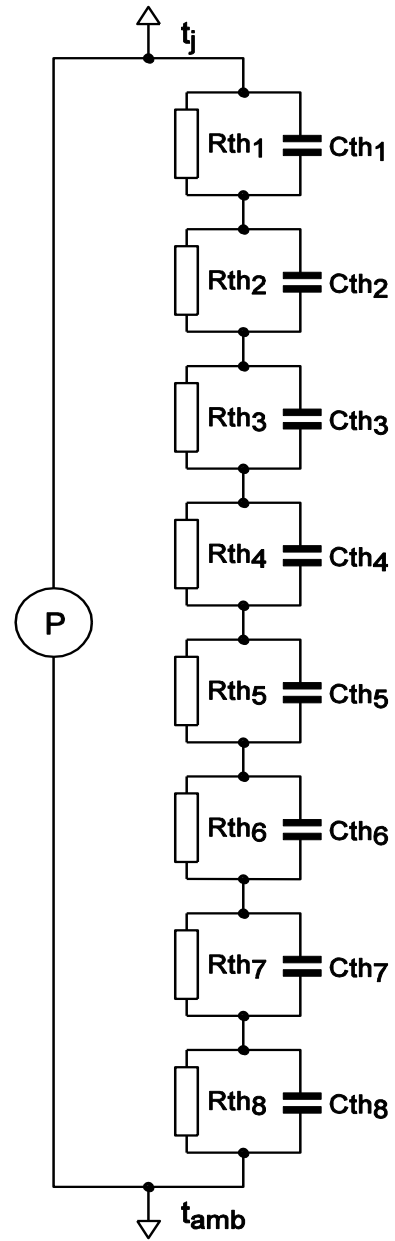

Part: BUK964R2-60E
 Date: 11/4/2013
 Model Rth 0.58 K/W